

Freigegeben

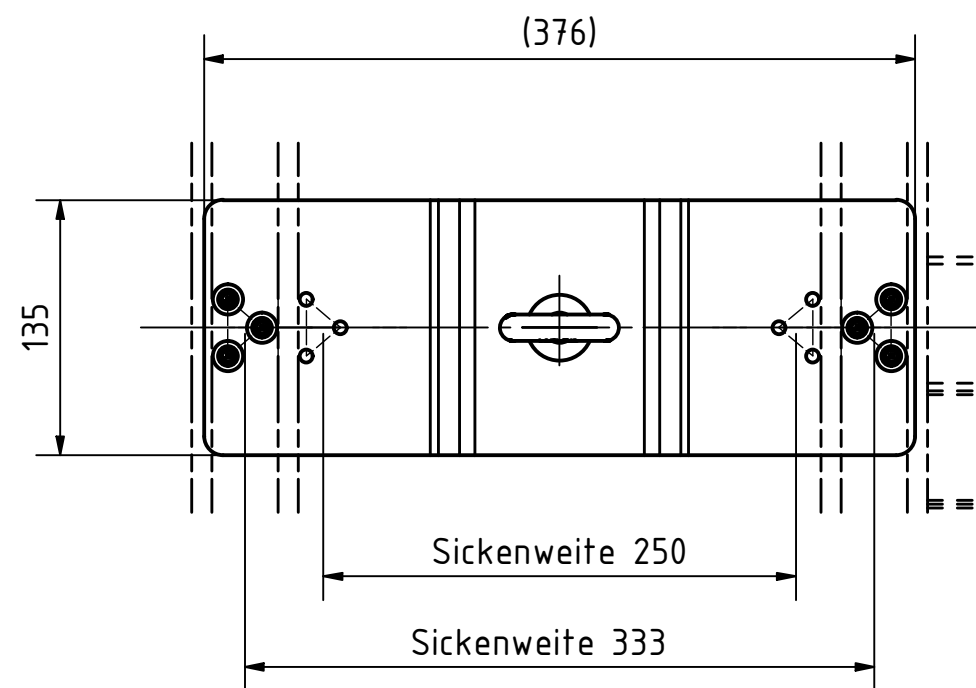

Teile ID. Part ID.		90-001727			Name (verantw.): Konstr./Tel.:	
Artikelnummer Item Number		LX-SW-6-400-160			<div style="border: 2px solid red; padding: 10px; display: inline-block;"> ABS[®] <small>Absturzsicherung mit System</small> </div>	
Beschreibung Description		ABS-Lock X-SW-6 Produktzeichnung				
	Datum	Name	Maßst. Scale	Projektionsmethode 1 First angle projection method	Maße ohne Toleranzangabe nach ISO 2768 m	
Gez.	11.12.2019	PJ	1 : 4	ISO 128	Format Size	Zeichnungs-Nr./Drawing-No.
Gepr.	02.03.2020	PJ	Werkstoff, Material	Stueckgew., Unit weight	A3	ENG-016517
Norm						
OE						
			Datei, File	ENG-016517.idw	CAD	Blatt Sheet 4 von of 17